

BIKINI

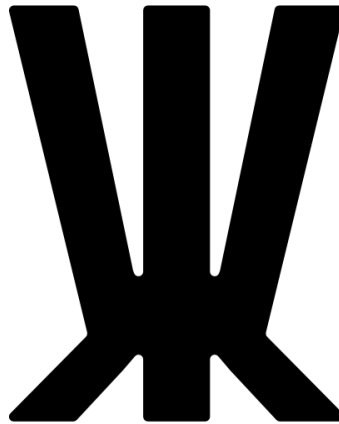

TEST

Bikini Test / Association KA
Joux-Perret 3
2300 La Chaux-de-Fonds
Switzerland

Stage Specs

Stage dimensions	Height :	0.8 m / 2.62 ft	Width :	8 m / 26.24 ft	Depth :	4 m / 13.12 ft
Backstage dimensions	Height :	0.8 m / 2.624 ft	Width :	6 m / 19.68 ft	Depth :	1 m / 3.28 ft
Dist to lightning pipes (From the stage)	Height :	4 m / 13.12 ft				
Power	Direct 235 V		Contact us for the power adapters, if different than EU standard			

Sound Specs

According to the swiss law the SOUND LEVEL LIMIT is : 100 db LeqA 60min

Main Stage

PA	6	L-Acoustics A15	4X Focus & 2X Wide
	4	L-Acoustics SB28	
	3	L-Acoustics LA8	
	2	L-Acoustics X8 (Front Fill)	

FOH	Console	1	Yamaha CL5
		1	Rio 3224-D2 DANTE
		1	Rio 1608-D2 DANTE
	Misc	1	10easy sound level meter

MON MONITORS ARE OPERATED FROM FOH / NO MONITORING DESK

Wedge	10	L-Acoustics 115XT HiQ
	4	L-Acoustics LA8

Small Stage

PA	2	L-Acoustics 108P
	1	L-Acoustics 15P

FOH	Console	1	Yamaha QL1
-----	---------	---	------------

MON MONITORS ARE OPERATED FROM FOH / NO MONITORING DESK

3	B-HYPE12 DB Technologies
---	--------------------------

MISC	Mics	2	AKG C414 XLII
		2	AKG C535EB
		1	AKG D112
		2	Audix D6
		1	Beyerdynamics M88TG
		3	Beyerdynamic OPUS88
		2	MBHO MBC660
		4	Sennheiser MD521
		3	Sennheiser e904
		5	Sennheiser e604
		1	Sennheiser e608
		1	Sennheiser e906
		8	Shure SM57
		6	Shure SM58
		4	Shure Beta57
		3	Shure Beta58
		1	Shure Beta87A
		1	Shure Beta91A
		3	Shure Beta98
		1	Shure Beta52
		2	Shure KSM32
		2	Telefunken USA M80
		DI	
2	Whirlwind Director/w. Jensen Transformers		
2	Klark Teknik LBB100		

- 2 Klark Teknik DN100
- 1 Palmer Stereo Pasie
- 2 Palmer PAN02
- 3 BSS AR133
- 2 Radial Engineering TWIN ISO

Light Specs

FOH	Console	1	grandMA3 compact XT (grand MA 2 & 3)
		1	Avolites Pearl Expert Titan
Fixtures	Profile	8	Martin Professional MAC Quantum Profile
		12	Martin Professional MAC Aura XB
		10	Martin Rush PAR 2 RGBW Zoom
	Conventional	36	Par 64, CP 60,61,62 Single
		6	ADB C101 PC
		8	ETC S4 Jr Zoom
		10	SHOWTEC Sunstrip Active MKII
		2	DTS 2 lamp blinder
	Fog	1	Hazebase The Fab
	Strob	1	Martin Atomic 3000
Dimming	Dimmers	1	Avolites T4 36 dimmer + 12 direct
		20	Socapex outupts
		1	Wieland patchbay
		1	32A three phase CEE Utility output
		2	16A mono phase CEE Utility output

Backline

GUITAR	Head	1	Marshall JCM2000 DSL100
	Cabinet	1	Marshall 1960 4x12 Lead Bottom
		1	Randall 4x12
Bass	Head	1	E-Bass Ampeg Classic SVT-CL
	Cabinet	1	E-Bass Ampeg Classic SVT-410HLF

DJ	Turntables	2	Pioneer PLX1000
		2	Pioneer XDJ1000 MKII
		1	Pioneer CDJ3000
Mixer	1	Pioneer DJM900NXS	
	1	Pioneer DJMA9	

Video

SCREEN	1	Vario 64, 16:9, 440x250cm
VPL	1	Acer PL7610T (WUXGA, 6000 lm, 1.36 - 2.18:1)

CONTACTS	Technical Director	Gwenaël Bonfanti	technique@bikinitest.ch
	Promoter	Joan Dubois	booking@bikinitest.ch

This rider is subject to minor changes - Updates will be forwarded

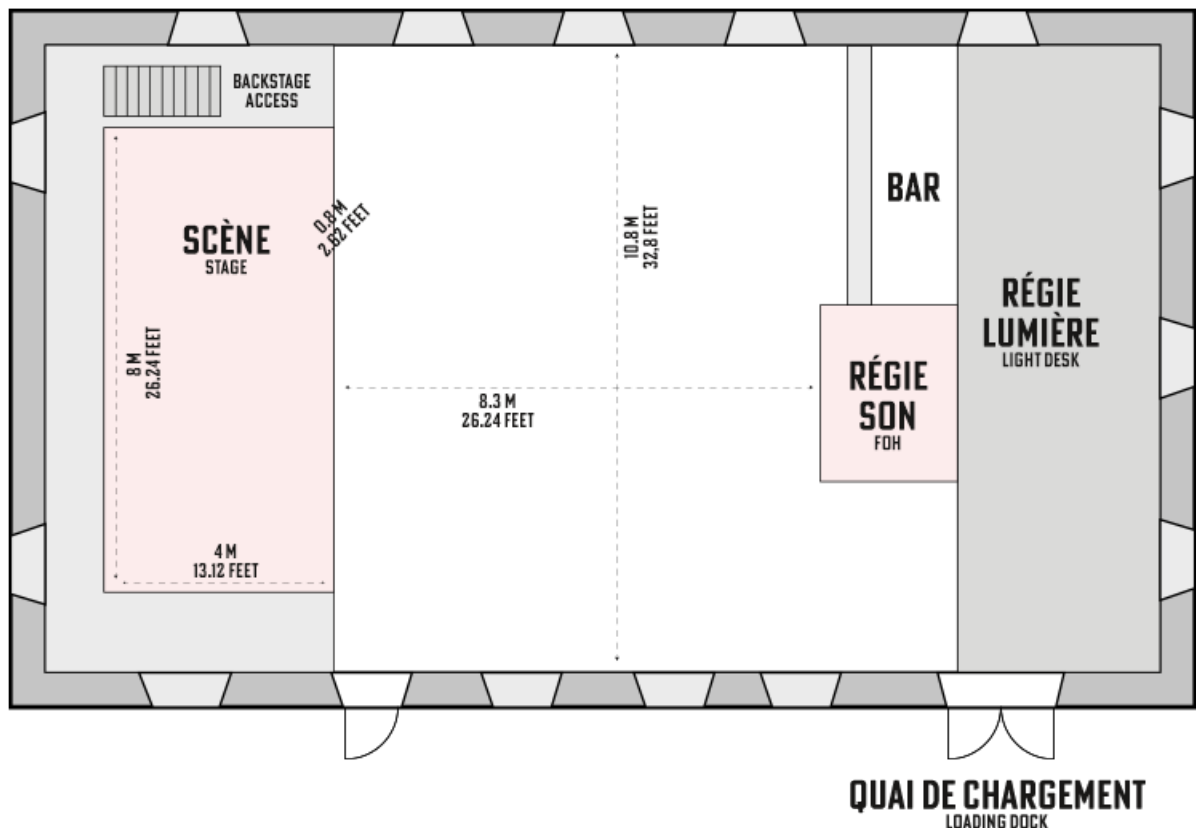

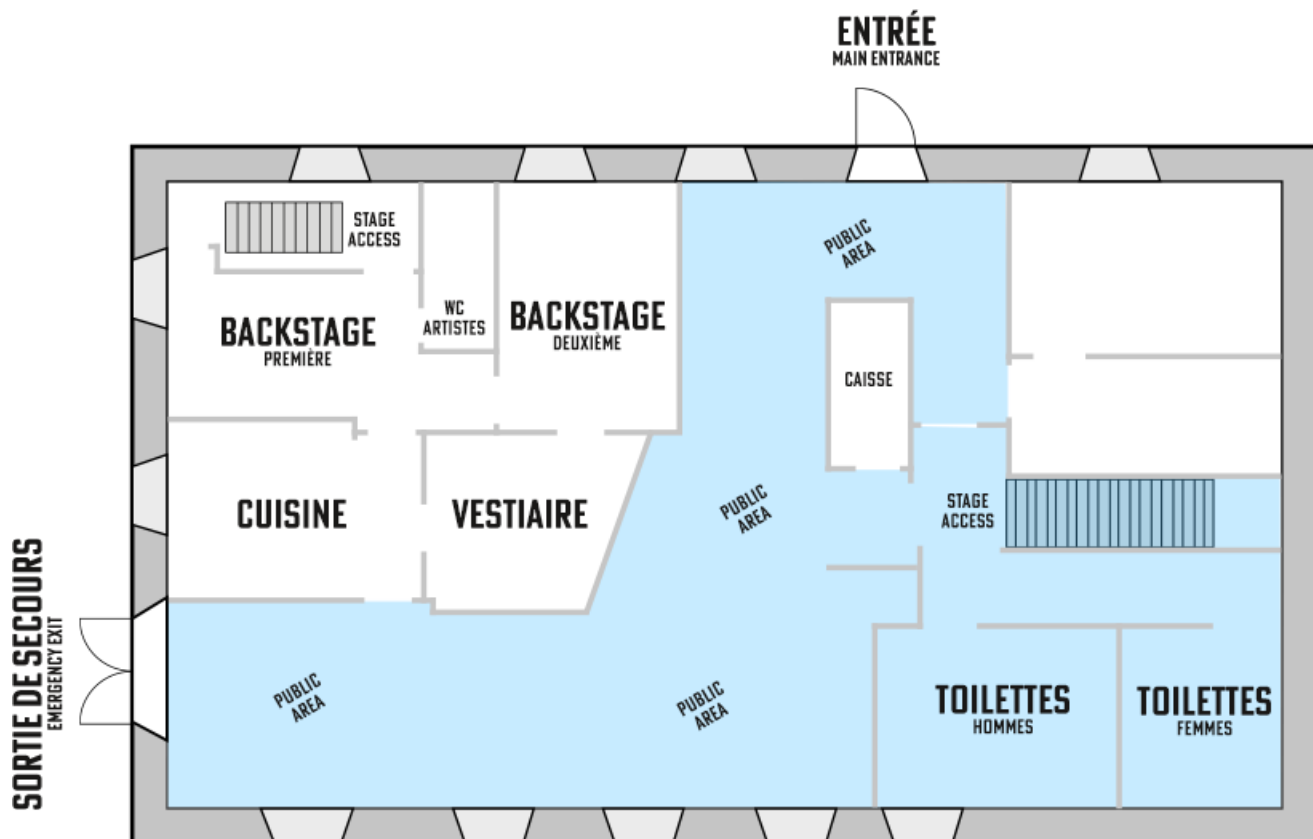

Bikini Test / Light Plot / 02.12.24

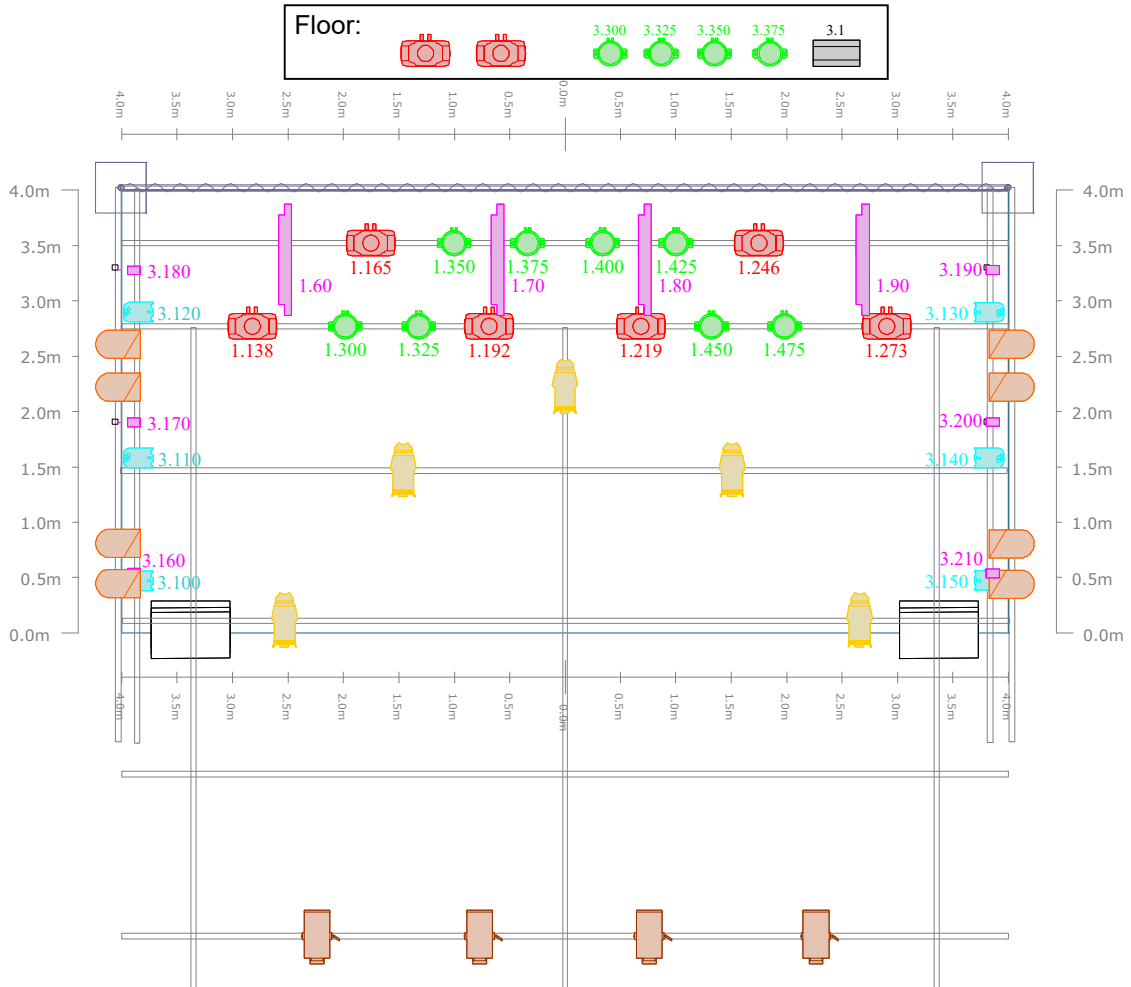

Node: 2.0.0.49 // 255.0.0.0
 Conventionals/Trad: 2.1-> 2.26
 HazeBase TheFab 3ch: 3.509
 Worklights + Ambiances: 3.501 -> 3.505

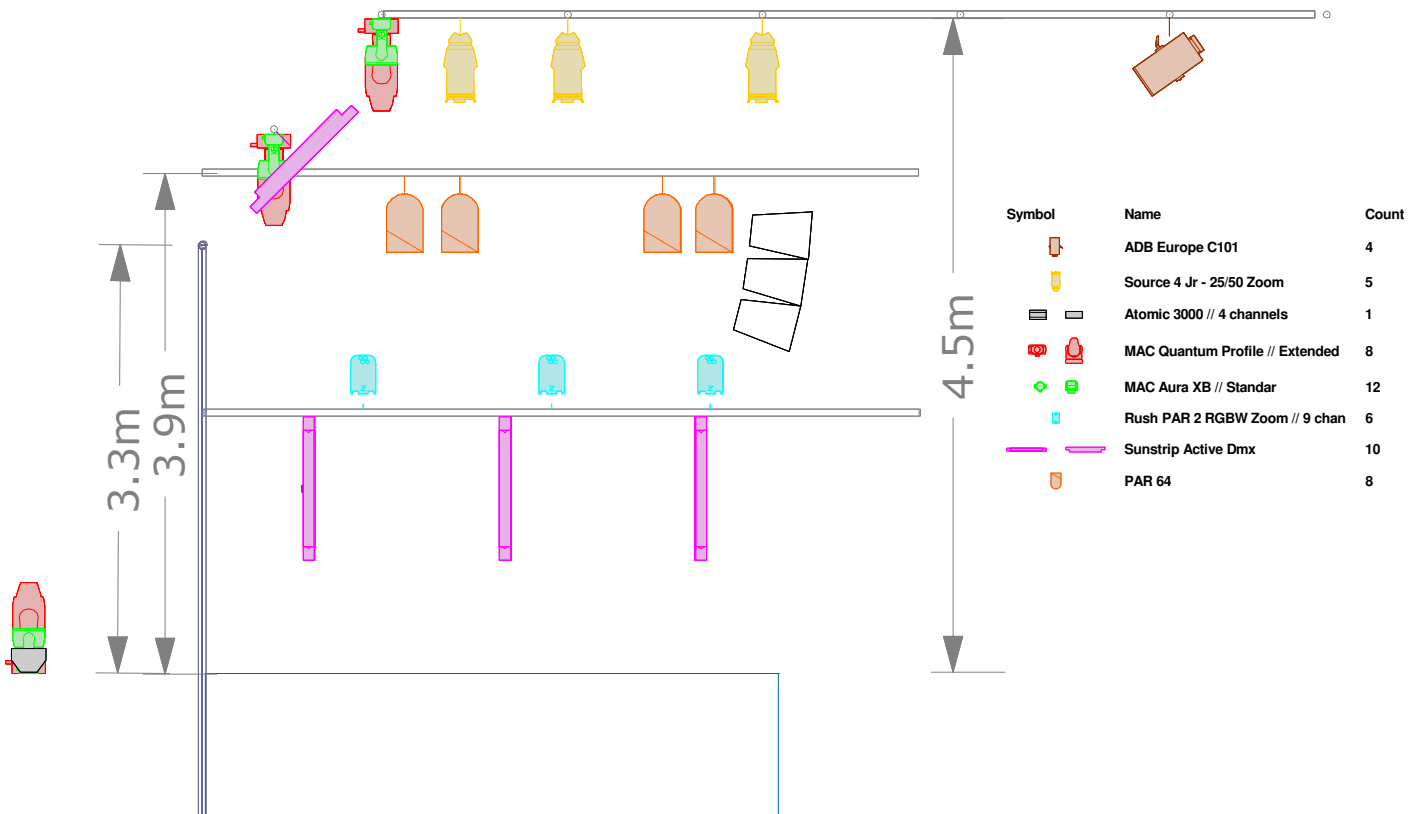

Block Diagram Bikini Test

